

New Plymouth
Steel
Supplies

VALVE
CATALOGUE

Valve Catalogue Contents

Ball Valves	Page 3-10
Bonomi Basic	3
Bonomi Microball	3
Bonomi Topic	4
Bonomi Topgas	4
Maxiflo	5
Bonomi Bibo Bib Cock	6
Bonomi Trio 3-way	6
Bonomi Duo 3-way	6
ITAP 3-way	6
Robex-VT Triple	7
Greenline Dezincification	7
Bonomi Eko Ball Bib Cock	7
T & S	7
Asmuss A-Ball	8,9,10
VM Stainless Steel	8,9
Neles Jamesbury Series 6150	10
Ciocca High Pressure	10

Butterfly Valves	Page 11-19
Asmuss A-Disc	11
Neles Jamesbury Neldisc	12
Neles Jamesbury Wafer-Sphere	12
Sentinel Monitored	12
Eurofly 600000	12
Bray Series	13, 14, 15
MAC Series	16
Bray Series	16, 17, 18
Bray Extension	18,19

Check Valves	Page 20-22
Mondial	20
Bonomi Valstop	20
ITAP Polymer	20
Europa	20
Bonomi Clapet	21
Liquetec Swing	21
Shurjoint	21
Fivalco	21
Astam Stainless	22
Maxiflo	22
Liquetec Lift	22
DK Piston	22
HSY	22

Gate Vales	Page 23-26
A-Gate	23
Liquetec	23
VOGT	24
Bonney Forge	24
DK	24
SUFA Stainless	24
Maxiflo	25
Shurjoint	25
SUFA Resilient	25
HSY	26
FABRI	26
CMO	26
ITAP	26

Globe Valves	Page 27-28
Liquetec	27, 28

Miscellaneous Valves	Page 29
-----------------------------	----------------

Strainers	Page 30
------------------	----------------

Relief Valves - Tosca	Page 31
------------------------------	----------------

Actuators	Page 32 - 33
------------------	---------------------

HVAC Valves	Page 34 - 39
--------------------	---------------------

NEW PLYMOUTH STEEL SUPPLIES LTD

BALL VALVES

8mm	10mm	15mm	20mm
25 PCS BOX	25 PCS BOX	15 PCS BOX	12 PCS BOX
25mm	32mm	40mm	50mm
12 PCS BOX	4 PCS BOX	4 PCS BOX	2 PCS BOX
65mm	80mm	100mm	
1 PCS BOX	1 PCS BOX	1 PCS BOX	

Code: BVS214

ENDS:
BSP F/F.

BODY & TRIM:
Nickel plated brass body, full bore
chrome plated brass ball PTFE seats.

RATING:
CWP - 50 bar size 8mm to 10 bar size
100mm. Max temp 150°C.

APPLICATIONS:
Hot and cold water, compressed air, oils,
non-aggressive chemicals, etc.

Bonomi Basic Ball Valve



15mm	20mm	25mm
PCS BOX	PCS BOX	PCS BOX
32mm	40mm	50mm
PCS BOX	PCS BOX	PCS BOX

Code: BVS218

T-HANDLE SIZES 15, 20, 25

Code: BVS215

LEVER HANDLE

ENDS:
BSP M/F.

BODY & TRIM:
Nickel plated brass body, full bore
chrome plated brass ball PTFE seats.

RATING:
CWP - 40 bar size 15mm to 20 bar size
50mm. Max temp 150°C.

APPLICATIONS:
Hot and cold water, compressed air, oils,
non-aggressive chemicals, etc.

Bonomi Basic Ball Valve

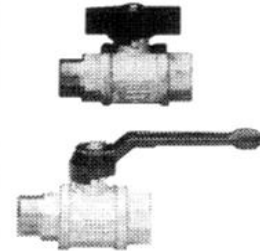

8mm	10mm	15mm	20mm
30 PCS BOX	28 PCS BOX	20 PCS BOX	12 PCS BOX
25mm			
9 PCS BOX			

Code: BVS217

ENDS:
BSP F/F.

BODY & TRIM:
Nickel plated brass body, full bore
chrome plated brass ball PTFE seats.

RATING:
CWP - 50 bar size 8mm to 30 bar size
25mm. Max temp 150°C.

APPLICATIONS:
Hot and cold water, compressed air, oils,
non-aggressive chemicals, etc.

Bonomi Basic Ball Valve

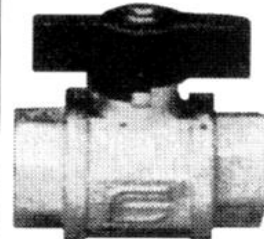

6mm	8mm	10mm	15mm
24 PCS BOX	24 PCS BOX	24 PCS BOX	24 PCS BOX

"NEW STYLE"

Code: BVM330	F/F LEVER
Code: BVM331	M/F LEVER
Code: BVM333	F/F SCREW

ENDS:
Screwed BSP F/F or M/F.

BODY & TRIM:
Nickel plated, reduced bore, brass
body. Chrome plated brass ball, PTFE
seats, NBR o-ring gland seal. Handle or
screwdriver operation.

RATING:
10 bar (150 psi) CWP. 90°C max.

APPLICATIONS:
A light, compact valve of neat
appearance. Suitable for water,
compressed air, etc.

Bonomi Microball Valve

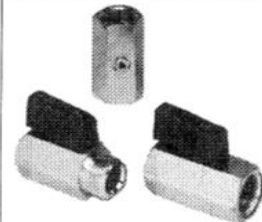

NEW PLYMOUTH STEEL SUPPLIES LTD

BALL VALVES

8mm	10mm	15mm	20mm
20 PCS BOX	20 PCS BOX	20 PCS BOX	12 PCS BOX
25mm	32mm	40mm	50mm
8 PCS BOX	4 PCS BOX	4 PCS BOX	2 PCS BOX
65mm	80mm	100mm	
1 PCS BOX	1 PCS BOX		

Code: BVT201

ENDS:
BSP TAPER F/F.

BODY & TRIM:
Nickel plated brass body, full bore chrome plated brass ball PTFE seats.

RATING:
CWP - 50 bar size 8mm to 12 bar size 100mm. Max temp 150°C.

APPLICATIONS:
Hot and cold water, compressed air, oils, non-aggressive chemicals, natural gas.



Bonomi Topic Ball Valve

8mm	10mm	15mm	20mm
30 PCS BOX	30 PCS BOX	30 PCS BOX	12 PCS BOX
25mm	32mm	40mm	50mm
9 PCS BOX			

Code: BVT208 T-HANDLE 8mm - 25mm
Code: BVT202 LEVER HANDLE 15mm - 50mm

ENDS:
BSP TAPER M/F.

BODY & TRIM:
Nickel plated brass body, full bore chrome plated brass ball PTFE seats.

RATING:
CWP - 45 bar size 15mm to 20 bar size 50mm. Max temp 150°C.

APPLICATIONS:
Hot and cold water, compressed air, oils, non-aggressive chemicals, natural gas.

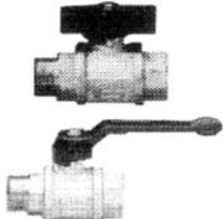

Bonomi Topic Ball Valve

8mm	10mm	15mm	20mm
30 PCS BOX	20 PCS BOX	25 PCS BOX	12 PCS BOX
25mm			
9 PCS BOX			

Code: BVT207

ENDS:
BSP TAPER F/F.

BODY & TRIM:
Nickel plated brass body, full bore chrome plated brass ball PTFE seats.

RATING:
CWP - 50 bar size 8mm to 35 bar size 25mm. Max temp 150°C.

APPLICATIONS:
Hot and cold water, compressed air, oils, non-aggressive chemicals, natural gas.



Bonomi Topic Ball Valve

15mm	20mm	25mm	32mm
20 PCS BOX	12 PCS BOX	8 PCS BOX	4 PCS BOX
40mm	50mm		
4 PCS BOX	2 PCS BOX		

Code: BVT221

ENDS:
BSP TAPER F/F.

BODY & TRIM:
Nickel plated brass body, full bore chrome plated brass ball PTFE seats.

RATING:
CWP - 50 bar size 8mm to 12 bar size 100mm. Max temp 150°C.

APPLICATIONS:
Hot and cold water, compressed air, oils, non-aggressive chemicals. Natural gas.

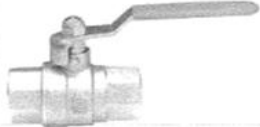

Bonomi Topgas Ball Valve with Yellow Handle

15mm	20mm	25mm	32mm
20 PCS BOX	12 PCS BOX	8 PCS BOX	4 PCS BOX
40mm	50mm		
4 PCS BOX	2 PCS BOX		

Code: BVT1LH

ENDS:
BSP TAPER F/F.

BODY & TRIM:
Nickel plated brass body, full bore chrome plated brass ball PTFE seats.

RATING:
CWP - 50 bar size 8mm to 12 bar size 100mm. Max temp 150°C.

Lockable handle in both closed and open positions.



Bonomi Topic Ball Valve with Lockable Handle

NEW PLYMOUTH STEEL SUPPLIES LTD

MAXIFLO BALL VALVES

8mm	10mm	15mm	20mm
25mm	32mm	40mm	50mm
65mm	80mm	100mm	

Code: MVBB

ENDS:
BSP F/F.

BODY & TRIM:
Nickel plated brass body, full bore chrome plated brass ball PTFE seats, lever handle.

RATING:
CWP – 50 bar size 8mm to 17 bar size 100mm. Max temp 150°C.

APPLICATIONS:
Hot and cold water, air, oils, non-aggressive chemicals.

*Maxiflo Brass Ball Valve
General Purpose*



8mm	10mm	15mm	20mm
25mm	32mm	40mm	50mm
65mm	80mm	100mm	

Code: MVGAS

Code: MVGAST T Handle 8mm to 25mm

ENDS:
BSP TAPER F/F.

BODY & TRIM:
Nickel plated brass body, full bore chrome plated brass ball PTFE seats, lever and tee handle.

RATING:
CWP – 50 bar size 8mm to 17 bar size 100mm. Max temp 150°C.

APPLICATIONS:
Hot and cold water, compressed air, oils, non-aggressive chemicals, natural gas. AGA approval 6017.

*Maxiflo Brass Ball Valve
Gas Approved*



8mm	10mm	15mm	20mm
25mm	32mm	40mm	50mm

Code: MVGASMF

Code: MVGASMFT 8mm to 25mm

ENDS:
BSP TAPER M/F.

BODY & TRIM:
Nickel plated brass body, full bore chrome plated brass ball PTFE seats, lever and tee handle.

RATING:
CWP – 50 bar size 8mm to 25 bar size 50mm. Max temp 150°C.

APPLICATIONS:
Hot and cold water, compressed air, oils, non-aggressive chemicals, natural gas. AGA approval 6017.

*Maxiflo Brass Ball Valve
Gas Approved*



15mm	20mm	25mm	32mm
40mm	50mm		

Code: MVBBD

ENDS:
BSP.

BODY & TRIM:
DZR body and ball stem, full bore PTFE seats, lever handle.

RATING:
CWP – 25 bar. Max temp 150°C.

APPLICATIONS:
Potable water.
Watermark Spec 012.
Licence no. W653.
AGA approval 6017.

*Maxiflo DZR Brass Ball Valve
Gas Approved*



15mm	20mm	25mm	32mm
40mm	50mm		

Code: MVGASLH

ENDS:
BSP TAPER M/F.

BODY & TRIM:
Nickel plated brass body, full bore chrome plated brass ball PTFE seats, lockable handle.

RATING:
CWP – 50 bar size 8mm to 17 bar size 100mm. Max temp 150°C.

APPLICATIONS:
Hot and cold water, compressed air, oils, non-aggressive chemicals, natural gas. AGA approval 6017.

*Lockable Handle Maxiflo
Ball Valve*





NEW PLYMOUTH STEEL SUPPLIES LTD

VALVES

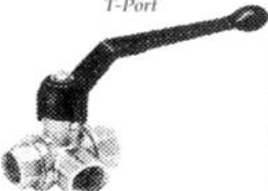
15mm					
Code: BVBIBO WITH BLUE BUTTON OR RED BUTTON					
<p>ENDS: Screwed BSP.</p> <p>BODY & TRIM: Nickel plated brass body, chrome plated brass ball, PTFE seats, o-ring stem seals.</p> <p>RATING: 16 bar CWP. Temp to 90°C.</p> <p>APPLICATIONS: Washing machine connections.</p>					
 <p><i>Bonomi Bibo Bib Cock</i></p>					

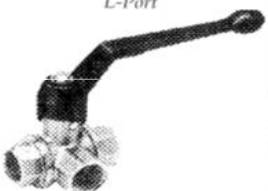
15mm	20mm	25mm	32mm		
40mm	50mm				
Code: BVTT					
<p>ENDS: Screwed BSP.</p> <p>BODY & TRIM: Nickel plated brass body, chrome plated brass ball, 4 PTFE seats and seals, special multi-position handle.</p> <p>RATING: 16 bar CWP. 150°C max.</p> <p>APPLICATIONS: Hot and cold water, compressed air, oils, gases, fuels, non-aggressive chemicals.</p>					
 <p><i>Bonomi Trio 3-Way Ball Valve T-Port</i></p>					

8mm	10mm	15mm	20mm		
25mm	32mm	40mm	50mm		
Code: BVTL					
<p>ENDS: Screwed BSP.</p> <p>BODY & TRIM: Nickel plated brass body, chrome plated brass ball, PTFE seats and seals.</p> <p>RATING: 10 bar CWP (150 psi). Temp 150°C max.</p> <p>APPLICATIONS: Hot and cold water, compressed air, oils, gases, fuels, non-aggressive chemicals.</p>					
 <p><i>Bonomi Duo 3-Way Ball Valve L-Port</i></p>					

15mm	20mm	25mm	32mm		
40mm	50mm				
Code: BVT 128					
<p>ENDS: Screwed BSP.</p> <p>BODY & TRIM: Nickel plated brass body, chrome plated brass ball, PTFE seats and seals.</p> <p>RATING: 16 bar CWP. 150°C max.</p> <p>APPLICATIONS: Hot and cold water, compressed air, oils.</p>					
 <p><i>ITAP 3-Way Ball Valve T-Port</i></p>					

15mm	20mm	25mm	32mm		
40mm	50mm				
Code: BVL 128					
<p>ENDS: Screwed BSP.</p> <p>BODY & TRIM: Nickel plated brass body, chrome plated brass ball, PTFE seats and seals.</p> <p>RATING: 16 bar CWP. 150°C max.</p> <p>APPLICATIONS: Hot and cold water, compressed air, oils.</p>					
 <p><i>ITAP 3-Way Ball Valve L-Port</i></p>					

NEW PLYMOUTH STEEL SUPPLIES LTD

BALL VALVES

<table border="1"> <tr> <td>15mm</td> <td>20mm</td> <td>25mm</td> <td>32mm</td> </tr> <tr> <td></td> <td></td> <td></td> <td></td> </tr> <tr> <td>40mm</td> <td>50mm</td> <td></td> <td></td> </tr> <tr> <td></td> <td></td> <td></td> <td></td> </tr> </table>	15mm	20mm	25mm	32mm					40mm	50mm							<p>ENDS: Screwed BSP F/F.</p> <p>BODY & TRIM: Body brass, full bore. Ball valve, PTFE seats, check valve nylon jumper, NBR seal, S/S spring.</p> <p>RATING: From 40 bar CWP for 15mm to 25 bar, 40mm. Temp. 100°C.</p> <p>APPLICATIONS: Water supply systems, HVAC, backflow prevention and test.</p>	<p><i>Robex-VT Triple Valve Combination Ball, Check, Test & Drain Valve</i></p> 
15mm	20mm	25mm	32mm															
40mm	50mm																	
<table border="1"> <tr> <td>15mm</td> <td>20mm</td> <td>25mm</td> </tr> <tr> <td></td> <td></td> <td></td> </tr> </table>	15mm	20mm	25mm				<p>ENDS: Screwed BSP, F/F.</p> <p>BODY & TRIM: Dezincification resistant copper alloy metals; PTFE seats.</p> <p>RATING: From 45 bar CWP for 15mm to 25 bar for 50mm. Temperatures to 150°C.</p> <p>APPLICATIONS: Services where chlorinated water or aggressive natural water causes zinc leaching in standard brass alloys.</p>	<p><i>Greenline Dezincification Resistant Ball Valve</i></p> 										
15mm	20mm	25mm																
<table border="1"> <tr> <td>10mm</td> <td>15mm</td> <td>20mm</td> <td>25mm</td> </tr> <tr> <td>12 PCS BOX</td> <td>12 PCS BOX</td> <td>6 PCS BOX</td> <td>4 PCS BOX</td> </tr> </table>	10mm	15mm	20mm	25mm	12 PCS BOX	12 PCS BOX	6 PCS BOX	4 PCS BOX	<p>ENDS: Screwed BSP/hose connector.</p> <p>BODY & TRIM: Nickel plated brass body, chrome plated brass ball, PTFE seats, o-ring stem seal.</p> <p>RATING: 10 bar (150 psi) CWP. 120°C max.</p> <p>APPLICATIONS: Hot and cold water, compressed air, oils, gases, fuels, non-aggressive chemicals, etc.</p>	<p><i>Bonomi Eko Ball Bib Cock</i></p> 								
10mm	15mm	20mm	25mm															
12 PCS BOX	12 PCS BOX	6 PCS BOX	4 PCS BOX															
<table border="1"> <tr> <td>15mm</td> <td>20mm</td> </tr> <tr> <td>20 PCS BOX</td> <td>12 PCS BOX</td> </tr> </table>	15mm	20mm	20 PCS BOX	12 PCS BOX	<p>ENDS: BSP M/F (male end for copper pipe).</p> <p>BODY & TRIM: Nickel plated brass body, full bore chrome plated brass ball, PTFE seats.</p> <p>RATING: CWP - 45 bar. Max. temp. 150°C.</p> <p>APPLICATIONS: Hot and cold water.</p>	<p><i>Bonomi Topic Ball Valve Male End for Copper Tube</i></p> 												
15mm	20mm																	
20 PCS BOX	12 PCS BOX																	
<table border="1"> <tr> <td>15mm</td> <td>20mm</td> <td>50mm</td> </tr> <tr> <td>12 PCS BOX</td> <td>10 PCS BOX</td> <td>2 PCS BOX</td> </tr> </table>	15mm	20mm	50mm	12 PCS BOX	10 PCS BOX	2 PCS BOX	<p>ENDS: BSP F/F.</p> <p>BODY & TRIM: Nickel plated brass body, chrome plated brass ball, PTFE seats.</p> <p>RATING: CWP - 27 bar. Max temp 120°C.</p> <p>APPLICATIONS: Irrigation.</p>	<p><i>T & S Ball Valve</i></p> 										
15mm	20mm	50mm																
12 PCS BOX	10 PCS BOX	2 PCS BOX																

NEW PLYMOUTH STEEL SUPPLIES LTD

BALL VALVES

8mm	10mm	15mm	20mm
25mm	32mm	40mm	50mm
65mm	80mm		

Code: ABVSS Screwed Ends

ENDS:
Screwed BSP taper.

BODY & TRIM:
3-piece 316 stainless steel body, ball and stem. Full bore. Glass reinforced PTFE seats and seals.

RATING:
69 bar CWP (1,000 psi). Temps up to 230°C.

APPLICATIONS:
General industrial use in a corrosive environment or with corrosive fluids, where serviceability is required.



Asmuss A-Ball Stainless Steel Ball Valve

8mm	10mm	15mm	20mm
25mm	32mm	40mm	50mm
65mm	80mm		

Code: VMBVSS Screwed Ends

ENDS:
Screwed BSP taper.

BODY & TRIM:
3-piece 316 stainless steel body, ball and stem. PTFE seats and seals.

RATING:
69 bar CWP (1,000 psi). Temps up to 210°C.

APPLICATIONS:
General industrial use in a corrosive environment or with corrosive fluids, where serviceability is required.



VM Stainless Steel Ball Valve

15mm	20mm	25mm	32mm
40mm	50mm		

Code: ABVSSST Screwed Ends

ENDS:
Screwed BSP taper.

BODY & TRIM:
3-piece 316 stainless steel body, ball and stem. Full bore. Graphite reinforced PTFE seats and seals.

RATING:
69 bar CWP (1,000 psi). Temps up to 230°C.

APPLICATIONS:
Steam service.



Asmuss A-Ball Stainless Steel Ball Valve with Steam Seats

8mm	10mm	15mm	20mm
25mm	32mm	40mm	50mm
65mm	80mm		

Code: VMBVSS2

ENDS:
Screwed BSP.

BODY & TRIM:
2-piece 316 S/S body, S/S ball and stem, PTFE seats and seals, full bore.

RATING:
CWP to 1,000 psi. Temps up to 200°C.

APPLICATIONS:
General industrial use, for corrosive fluids.



VM Stainless Steel Ball Valve

15mm	20mm	25mm	32mm
40mm	50mm		

Code: ABVCS Screwed Ends
Code: ABVCSW Socket Weld Ends

EXISTING STOCK ONLY

ENDS:
Screwed BSP and socket weld. (Sched 40)

BODY & TRIM:
3-piece carbon steel body, stainless steel ball and stem, full bore. Graphite reinforced PTFE seats/seals.

RATING:
69 bar CWP (1,000 psi). Temps up to 230°C.

APPLICATIONS:
General industrial use where serviceability is required.



Asmuss A-Ball Carbon Steel Ball Valve

NEW PLYMOUTH STEEL SUPPLIES LTD

BALL VALVES																		
<table border="1"> <tr> <th>25mm</th> <th>40mm</th> <th>50mm</th> <th>65mm</th> </tr> <tr> <td> </td> <td> </td> <td> </td> <td> </td> </tr> <tr> <th>80mm</th> <th>100mm</th> <th>150mm</th> <td> </td> </tr> <tr> <td> </td> <td> </td> <td> </td> <td> </td> </tr> </table> <p>Code: ABVCS150</p>	25mm	40mm	50mm	65mm					80mm	100mm	150mm						<p>ENDS: Flanged ANSI 150. BODY & TRIM: 2-piece cast steel body, S/S ball, RPTFE seats, full bore. RATING: ANSI 150. APPLICATIONS: General industry, hydrocarbon and mineral processes.</p>	<p><i>Asmuss A-Ball CS Ball Valve M215</i></p> 
25mm	40mm	50mm	65mm															
80mm	100mm	150mm																
<table border="1"> <tr> <th>15mm</th> <th>20mm</th> <th>25mm</th> <th>40mm</th> </tr> <tr> <td> </td> <td> </td> <td> </td> <td> </td> </tr> <tr> <th>50mm</th> <th>65mm</th> <th>80mm</th> <th>100mm</th> </tr> <tr> <td> </td> <td> </td> <td> </td> <td> </td> </tr> </table> <p>Code: ABVSS150</p>	15mm	20mm	25mm	40mm					50mm	65mm	80mm	100mm					<p>ENDS: Flanged ANSI 150. BODY & TRIM: 2-piece ASTM CF8M body and ball, RPTFE seats, full bore. RATING: ANSI 150. APPLICATIONS: General industry, hydrocarbon and mineral processes.</p>	<p><i>Asmuss A-Ball Stainless Steel Ball Valve M215</i></p> 
15mm	20mm	25mm	40mm															
50mm	65mm	80mm	100mm															
<table border="1"> <tr> <th>10mm</th> <th>15mm</th> <th>20mm</th> <th>25mm</th> </tr> <tr> <td> </td> <td> </td> <td> </td> <td> </td> </tr> <tr> <th>32mm</th> <th>40mm</th> <th>50mm</th> <td> </td> </tr> <tr> <td> </td> <td> </td> <td> </td> <td> </td> </tr> </table> <p>Code: ABVSSSWL Socket Weld Ends (SCH40)</p>	10mm	15mm	20mm	25mm					32mm	40mm	50mm						<p>ENDS: Socket weld to suit Sched 40. BODY & TRIM: Ends 316L. Body, ball and stem 316 S/S. Full bore. Glass reinforced PTFE seats and seals. RATING: 69 bar CPW (1,000 psi). Temperatures up to 230°C. APPLICATIONS: General industrial use in a corrosive environment or with corrosive fluids, where serviceability is required.</p>	<p><i>Asmuss A-Ball Stainless Steel Socket Weld Ball Valve 316L Ends</i></p> 
10mm	15mm	20mm	25mm															
32mm	40mm	50mm																
<table border="1"> <tr> <th>15mm</th> <th>20mm</th> <th>25mm</th> <th>40mm</th> </tr> <tr> <td> </td> <td> </td> <td> </td> <td> </td> </tr> <tr> <th>50mm</th> <td> </td> <td> </td> <td> </td> </tr> <tr> <td> </td> <td> </td> <td> </td> <td> </td> </tr> </table> <p>Code: ABVSSSTU Socket Weld Ends to suit S/S OD Tube</p>	15mm	20mm	25mm	40mm					50mm								<p>ENDS: Socket weld to suit S/S OD Tube. BODY & TRIM: Ends 316L. Body, ball and stem 316 S/S. Full bore. Glass reinforced PTFE seats and seals. RATING: 69 bar CPW (1,000 psi). Temperatures up to 230°C. APPLICATIONS: General industrial use in a corrosive/food environment or with corrosive fluids, where serviceability is required.</p>	<p><i>Asmuss A-Ball Stainless Steel Socket Weld Ball Valve for S/S OD Tube</i></p> 
15mm	20mm	25mm	40mm															
50mm																		
<table border="1"> <tr> <th>15mm</th> <th>20mm</th> <th>25mm</th> <th>32mm</th> </tr> <tr> <td> </td> <td> </td> <td> </td> <td> </td> </tr> <tr> <th>40mm</th> <th>50mm</th> <td> </td> <td> </td> </tr> <tr> <td> </td> <td> </td> <td> </td> <td> </td> </tr> </table> <p>Code: VMBVISO</p>	15mm	20mm	25mm	32mm					40mm	50mm							<p>ENDS: Screwed BSP taper. BODY & TRIM: 3-piece 316 stainless steel body, ball and stem. PTFE seats and seals. RATING: 69 bar CPW (1,000 psi). Temps up to 230°C. APPLICATIONS: General industrial use in a corrosive/food environment or with corrosive fluids, where serviceability is required.</p>	<p><i>VM Stainless Steel Ball Valve ISO top plate</i></p> 
15mm	20mm	25mm	32mm															
40mm	50mm																	

NEW PLYMOUTH STEEL SUPPLIES LTD

BALL VALVES

<table border="1"> <tr> <th>50mm</th> <th>80mm</th> <th>100mm</th> </tr> <tr> <td> </td> <td> </td> <td> </td> </tr> </table>	50mm	80mm	100mm				<p>ENDS: Flanged ANSI 150.</p> <p>BODY & TRIM: C/S body, S/S trim, PTFE seats, lever operated, manufactured to BS5351.</p> <p>RATING: ANSI Class 150, firesafe to API607, BS6755.</p> <p>APPLICATIONS: General industry, fuels, gases, oil, chemicals, etc.</p>	<p><i>Neles Jamesbury Series 6150 Ball Valve</i></p> 										
50mm	80mm	100mm																
<table border="1"> <tr> <th>8mm</th> <th>10mm</th> <th>15mm</th> <th>20mm</th> </tr> <tr> <td> </td> <td> </td> <td> </td> <td> </td> </tr> <tr> <th>25mm</th> <th>32mm</th> <th>40mm</th> <td> </td> </tr> <tr> <td> </td> <td> </td> <td> </td> <td> </td> </tr> </table>	8mm	10mm	15mm	20mm					25mm	32mm	40mm						<p>ENDS: Screwed BSP parallel.</p> <p>BODY & TRIM: Zinc plated steel body, chrome plated steel ball, Delrin seats, NBR seals.</p> <p>RATING: Up to 15mm 500 BAR. 20mm and up. 320 BAR. Temp. -20°C to 100°C.</p> <p>APPLICATIONS: High pressure liquids and gases.</p>	<p><i>Cioca High Pressure Ball Valve</i></p> 
8mm	10mm	15mm	20mm															
25mm	32mm	40mm																
<table border="1"> <tr> <th>15mm</th> <th>20mm</th> <th>25mm</th> </tr> <tr> <td> </td> <td> </td> <td> </td> </tr> </table>	15mm	20mm	25mm				<p>ENDS: Screwed BSP parallel.</p> <p>BODY & TRIM: Zinc plated steel body, chrome plated steel ball, Delrin seats, NBR seals.</p> <p>RATING: Up to 15mm 500 BAR. 20mm and up. 320 BAR. Temp. -20°C to 100°C.</p> <p>APPLICATIONS: High pressure liquids and gas service.</p>	<p><i>Cioca High Pressure 3-Way L Port Ball Valve</i></p> 										
15mm	20mm	25mm																
<table border="1"> <tr> <th>15mm</th> <th>20mm</th> <th>25mm</th> <th>32mm</th> </tr> <tr> <td> </td> <td> </td> <td> </td> <td> </td> </tr> <tr> <th>40mm</th> <th>50mm</th> <td> </td> <td> </td> </tr> <tr> <td> </td> <td> </td> <td> </td> <td> </td> </tr> </table>	15mm	20mm	25mm	32mm					40mm	50mm							<p>ENDS: Screwed BSP.</p> <p>BODY & TRIM: 316 S/S body, ball and stem. Reinforced PTFE seats.</p> <p>RATING: 55 Bar CWP (800 PSI). Temperatures up to 230°C.</p> <p>APPLICATIONS: General industry and chemical service where diverting to on or two ports is required.</p>	<p><i>Asmuss A-Ball 3 Way L & T Port 316 S/S Ball Valves</i></p> 
15mm	20mm	25mm	32mm															
40mm	50mm																	
<table border="1"> <tr> <td>Code: ABVSSL</td> <td>L PORT</td> </tr> <tr> <td>Code: ABVSST</td> <td>T PORT</td> </tr> </table>	Code: ABVSSL	L PORT	Code: ABVSST	T PORT														
Code: ABVSSL	L PORT																	
Code: ABVSST	T PORT																	

NEW PLYMOUTH STEEL SUPPLIES LTD

BUTTERFLY VALVES

50mm	65mm	80mm	100mm
125mm	150mm	200mm	250mm
300mm			

Code: ADVWE316 EPDM Seat
Code: ADVWN316 NITRILE Seat

ENDS:
Wafer. Table D, E, ANSI 125, 150, PN 10, 16.

BODY & TRIM:
CI body, 316, S/S disc, EPDM or NITRILE seat, lever operated.

RATING:
14 bar CWP, EPDM seat to 110°C.
NITRILE seat to 90°C.

Asmuss A-Disc Butterfly Valve

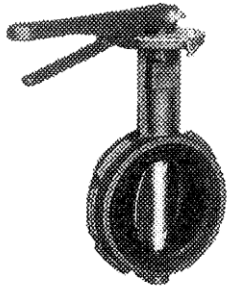

50mm	65mm	80mm	100mm
125mm	150mm	200mm	250mm
300mm			

Code: ADVLE316 T/E - EPDM
Code: ADVLNA316 ANSI - NITRILE
Code: ADVLEM316 PN16 EPDM

ENDS:
Lugged. BS10 T/E, with EPDM seat
Lugged. ANSI 150, with NITRILE seat
Lugged. BS4504 PN16 EPDM seat

BODY & TRIM:
CI body, 316 S/S disc, lever operated.

SEAT:
EPDM or NITRILE.

RATING:
14 bar CWP, EPDM seat to 110°C.
NITRILE seat to 90°C.

Asmuss A-Disc Butterfly Valve

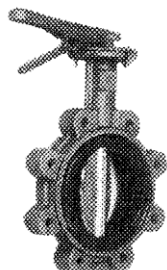

50-80mm	100mm	125-150mm	200mm
250mm	300mm		

Code: ADGO ADGOSS

GEAR OPERATOR
For A-disc butterfly valves.
Complete with handwheel, includes mounting bolts.
Sizes: 50mm to 300mm.

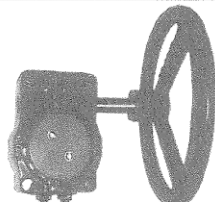

350mm	400mm

Code: ADVWE316G

ENDS:
Wafer. Table E.

BODY & TRIM:
CI body, 316, S/S disc, EPDM seat, gear operator.

RATING:
14 bar CWP, EPDM seat to 110°C.

Asmuss A-Disc Butterfly Valve



350mm	400mm

Code: ADVLEG316

ENDS:
Lugged. Table E.

BODY & TRIM:
CI body, 316, S/S disc, EPDM seat, gear operator.

RATING:
14 bar CWP, EPDM seat to 110°C.

Asmuss A-Disc Butterfly Valve



NEW PLYMOUTH STEEL SUPPLIES LTD

BUTTERFLY VALVES

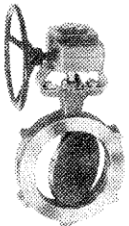
<p>Sizes 80mm & up</p> <p>Code: NJL1</p>	<p>ENDS: Wafer/lugged.</p> <p>BODY & TRIM: 316 S/S body and disc, S/S seat, gear operated.</p> <p>RATING: ANSI Class 150 and up.</p> <p>APPLICATIONS: Steam, chemicals, liquors, water, pulp stock, etc.</p>	<p><i>Neles-Jamesbury Neldisc Metal Seated Butterfly Valve</i></p> 
---	--	--

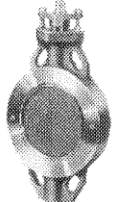
<p>100mm 150mm 200mm</p> <p>Code: NJ815W</p>	<p>ENDS: Wafer.</p> <p>BODY & TRIM: Carbon steel body, stainless steel disc, PTFE seats, lever operated.</p> <p>RATING: ANSI Class 150.</p> <p>APPLICATIONS: Steam, gases, chemicals, etc.</p>	<p><i>Neles-Jamesbury Wafer-Sphere PTFE Seated Butterfly Valve</i></p> 
---	--	--

<p>65mm 80mm 100mm 150mm</p> <p>200mm</p> <p>Code: SVBV</p>	<p>ENDS: Roll groove.</p> <p>BODY & TRIM: S.G. iron body, epoxy coated. Disc aluminium bronze, EPDM coated.</p> <p>RATING: 12 bar (175 psi).</p> <p>APPLICATIONS: Fire protection systems, indoor use. Valve is complete with switch for alarm service. Insurance Council approved.</p>	<p><i>Sentinel Monitored Butterfly Valve – Indoor Use</i></p> 
---	---	---

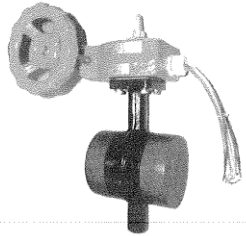
<p>100mm 150mm 200mm</p> <p>Code: SVBO</p>	<p>ENDS: Roll groove.</p> <p>BODY & TRIM: S.G. iron body, epoxy coated. Disc aluminium bronze, EPDM coated.</p> <p>RATING: 16 bar.</p> <p>APPLICATIONS: Fire protection systems, outdoor use. Valve is complete with switch for alarm service.</p>	<p><i>Sentinel Monitored Butterfly Valve – Outdoor Use</i></p> 
---	--	--

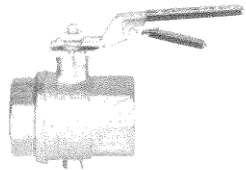
<p>15mm 20mm 25mm 32mm</p> <p>40mm 50mm</p> <p>Code: RBVE</p>	<p>ENDS: Screwed BSP.</p> <p>BODY & TRIM: Nickel plated brass body, PEI-Polyetheramide Disc, NBR seat, Adjustable throttling lever.</p> <p>RATING: 16 bar CWP. -10+100°C.</p> <p>APPLICATIONS: Water, oil or gas, Irrigation service where heavy frost/freezing conditions apply.</p>	<p><i>Eurofly 600000 Butterfly Valve</i></p> 
---	---	--

NEW PLYMOUTH STEEL SUPPLIES LTD

BRAY BUTTERFLY VALVES

SEAT	EPDM / BUNA	EPDM / BUNA	EPDM / BUNA
DISC	316SS	BRONZE	NYLON 11
50mm			
65mm			
80mm			
100mm			
125mm			
150mm			
200mm			
TRIM CODE	124 / 125	114 / 115	108 / 109
250mm			
300mm			
TRIM CODE	156 / 157	116 / 117	110 / 111

Body Code: BRVW30

WAFER BUTTERFLY VALVE

ENDS:
Wafer T/D.E ANSI 125/150.
BODY: C.I. Epoxy coated.
DISC: - 316 s/s.
- Aluminium bronze.
- Nylon 11 coated ductile iron.
SEAT: - EPDM.
- BUNA-N.
SHAFT: - 316 s/s.
- 304 s/s.
RATING:
12 bar to 121°C depending on seat/disc material.
APPLICATIONS:
Air, water, chemicals, slurries, hydrocarbons, gas, oil, etc.

Bray Series 30 Butterfly Valve

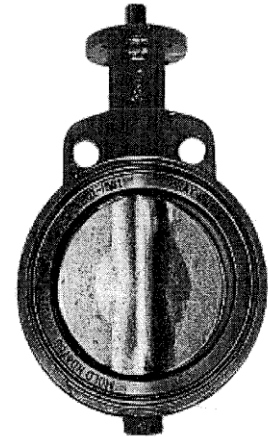

SEAT	EPDM / BUNA	EPDM / BUNA	EPDM / BUNA
DISC	316SS	BRONZE	NYLON 11
50mm			
65mm			
80mm			
100mm			
125mm			
150mm			
TRIM CODE	124 / 125	114 / 115	108 / 109
250mm			
300mm			
TRIM CODE	156 / 157	116 / 117	110 / 111

Body Code: BRVL31

LUGGED BUTTERFLY VALVE

ENDS:
Lugged BS10.E (metric tapping),
Lugged ANSI 150 (UNC tapping).
BODY: C.I. Epoxy coated.
DISC: - 316 s/s.
- Aluminium bronze.
- Nylon 11 coated ductile iron.
SEAT: - EPDM.
SHAFT: - 316 s/s.
- 304 s/s.
RATING:
12 bar to 121°C depending on seat/disc material.
APPLICATIONS:
Air, water, chemicals, slurries, hydrocarbons, gas, oil, etc.

Bray Series 31 Butterfly Valve

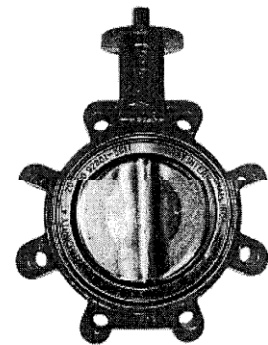

SEAT	EPDM / BUNA	EPDM / BUNA	PTFE	PTFE
DISC	316SS	EPDM / BUNA	316SS	PTFE
25mm				
40mm				
50mm				
65mm				
80mm				
100mm				
125mm				
150mm				
200mm				
250mm				
300mm				
TRIM CODE	124 / 125	128 / 129	126	127

Body Code: BRVW20

WAFER BUTTERFLY VALVE

ENDS:
Wafer T/D.E ANSI 125/150.
BODY: C.I. nylon 11 coated.
DISC: - 316 s/s.
- EPDM encapsulated.
- PTFE encapsulated.
SEAT: - EPDM.
- BUNA-N.
- PTFE.
RATING:
Up to 10 bar, 121°C depending on seat/disc material.
APPLICATIONS:
Air, water, chemicals, slurries, food products, hydrocarbons, gas, oil, etc.

Bray Series 20 Butterfly Valve

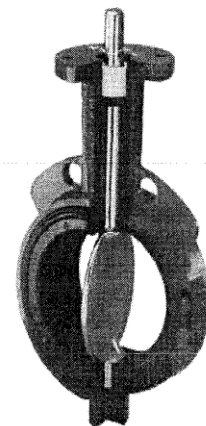

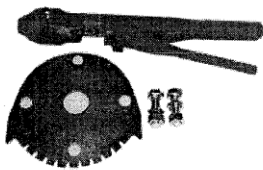

NEW PLYMOUTH STEEL SUPPLIES LTD

BRAY BUTTERFLY VALVES

25mm to 40mm	50mm to 80mm	HANDLE KIT CONSISTS OF: Handle, notch plate, 2 sets bolts, nuts, washers. 0° to 90° (10° increments).	<i>Bray Series 01 Handle Kit</i> 	
100mm	125mm to 150mm			200mm
250mm to 300mm				

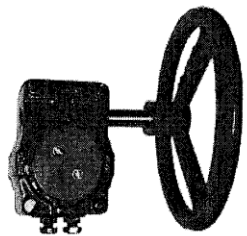
Code: BRVHK

0200	0300	GEAR OPERATOR Complete with handwheel includes mounting bolts. SIZE: 0200 - 50mm to 150mm valve 0300 - 200mm to 300mm valve. Remember shaft adaptor if required.	<i>Bray Series 04 Gear Operator</i> 
Code: BRVG			

90-50	90-61	90-63	90-83	ACTUATOR - PNEUMATIC Pneumatic, double-acting. WORKING CONDITIONS: Normal air supply 5.6 bar, max 10 bar dry filtered air, temperature -25°C to 95°C. DESIGN: Rack & pinion, low friction seals and guides, lubricated for life, anodised housing, maintenance free. Remember shaft adaptor if required.	<i>Bray Series 90 Double-acting Actuator</i> 
90-92	90-118	90-127	90-160		
90-210	90-255	Code: BRVACT90			

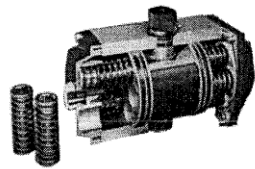
91-50	91-63	91-83	91-92	SPRING RETURN ACTUATORS (PNEUMATIC) Refer to Bray Catalogue for selection and quantity of springs. Spring cartridges to make actuators fail close or fail open.	<i>Bray Spring Cartridges for Return Actuators</i> 
91-118	91-127	91-160	91-210		
91-255	Code: BRVCAR91				

NEW PLYMOUTH STEEL SUPPLIES LTD

BRAY BUTTERFLY VALVES

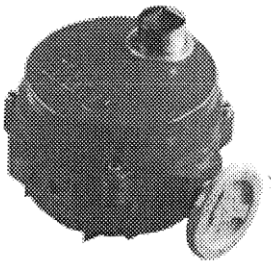
70-003	70-005	70-008	70-012	<p>ELECTRIC ACTUATOR</p> <p>220 vac, 50 hz, 1 ph, on/off operation c/w manual override and travel switches, mechanical/adjustable travel stops, diecast powder coated enclosure to nema 4, 4X IP65, heater to prevent condensation build-up, direct mount to Bray butterfly valves, servo option for modulating control is also available.</p> <p>Remember Shaft Adaptor if required.</p>	<p><i>Bray Series 70 Electric Actuator</i></p> 		
<table border="1" style="width: 100%; border-collapse: collapse;"> <tr> <td style="text-align: center;">70-020</td> </tr> <tr> <td style="height: 20px;"></td> </tr> </table>				70-020			
70-020							
<div style="border: 1px solid black; display: inline-block; padding: 2px;">Code: BRVACTEL</div>							

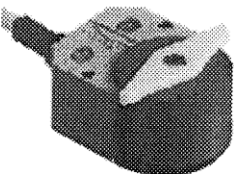
20-250 VAC	10-30 VDC	<p>PROX SENSORS - OPEN/CLOSE</p> <p>Nylon enclosure filled with epoxy resin to give maximum protection against moisture and vibration, direct mount to Bray pneumatic actuators; c/w LED indicators and multi-pin electrical cable for ease of installation. No spark, no bounce, no moving parts gives extended performance.</p>	<p><i>Bray Series 52 Proximity Sensor</i></p> 
<div style="border: 1px solid black; display: inline-block; padding: 2px;">Code: BRVPROX</div>			

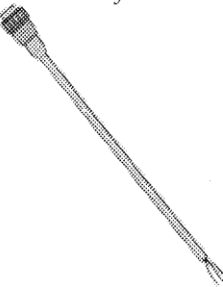
MINI AC 4 METRE	EURO DC 4 METRE	<p>CORDSETS</p> <p>Mini 5 pin for AC sensors, Euro 4 pin for DC sensors, gold plated contact pins, s/s coupling nut for corrosion resistance and secure weatherproof fit, giving easy installation/assembly.</p> <p>Plug connection to Prox Sensor with flying leads to junction box.</p>	<p><i>Bray Cordset for Series 52 Proximity Sensor</i></p> 		
<table border="1" style="width: 100%; border-collapse: collapse;"> <tr> <td style="text-align: center;">EURO DC 6 METRE</td> </tr> <tr> <td style="height: 20px;"></td> </tr> </table>		EURO DC 6 METRE			
EURO DC 6 METRE					
<div style="border: 1px solid black; display: inline-block; padding: 2px;">Code: BRVPXCOR</div>					

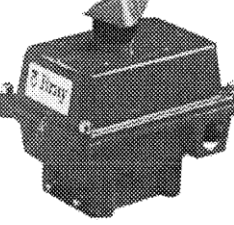
<div style="border: 1px solid black; width: 100%; height: 20px;"></div>	<p>SWITCH BOX</p> <p>Diecast aluminium housing, waterproof (nema 4,4X), adjustable cams, o-ring cover seal, acetal shaft, bearings, 2 SPDT micro switches, 15a - 250VAC.</p> <p>APPLICATION: Signals actuator/valve position as open/closed.</p>	<p><i>Bray Series 50 Limit Switch Box</i></p> 
<div style="border: 1px solid black; display: inline-block; padding: 2px;">Code: BRVSW50/0400</div>		

NEW PLYMOUTH STEEL SUPPLIES LTD

BRAY BUTTERFLY VALVES

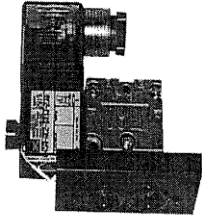
<table border="1"> <tr> <td>Code: BRVMAC45/24AS</td> <td rowspan="2">Actuator 50 to 92</td> </tr> <tr> <td>Code: BRVMAC45/24DS</td> </tr> <tr> <td>Code: BRVMAC45/110AS</td> <td rowspan="4">Actuator 118 to 255</td> </tr> <tr> <td>Code: BRVMAC45/240AS</td> </tr> <tr> <td>Code: BRVMAC45/24AL</td> </tr> <tr> <td>Code: BRVMAC45/24DL</td> </tr> <tr> <td>Code: BRVMAC45/110AL</td> <td></td> </tr> <tr> <td>Code: BRVMAC45/240AL</td> <td></td> </tr> </table>		Code: BRVMAC45/24AS	Actuator 50 to 92	Code: BRVMAC45/24DS	Code: BRVMAC45/110AS	Actuator 118 to 255	Code: BRVMAC45/240AS	Code: BRVMAC45/24AL	Code: BRVMAC45/24DL	Code: BRVMAC45/110AL		Code: BRVMAC45/240AL		<p>MAC 45 SOLENOID Pilot operated spool, direct mounting, speed controls, manual override, plug connection, continuous duty cycle.</p> <p>APPLICATION: Controls flow of air to drive pneumatic actuators, open/close.</p>	<p><i>MAC Series 45 Solenoid</i></p> 
Code: BRVMAC45/24AS	Actuator 50 to 92														
Code: BRVMAC45/24DS															
Code: BRVMAC45/110AS	Actuator 118 to 255														
Code: BRVMAC45/240AS															
Code: BRVMAC45/24AL															
Code: BRVMAC45/24DL															
Code: BRVMAC45/110AL															
Code: BRVMAC45/240AL															

<table border="1"> <tr> <td>Code: BRVSOLS60/220A</td> </tr> </table>	Code: BRVSOLS60/220A	<p>SOLENOID Pilot operated spool, direct mounting, manual override, nema 4 housing, 220VAC coil, DIN female plug, cv = 0.6 continuous duty cycle.</p> <p>APPLICATION: Controls flow of air to drive pneumatic actuators, open/close.</p>	<p><i>Bray Series 60 Solenoid</i></p> 
Code: BRVSOLS60/220A			

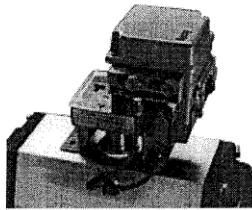
<table border="1"> <tr> <td>DOUBLE ACTING</td> </tr> <tr> <td>SINGLE ACTING</td> </tr> </table> <p>NB. MOUNTING KIT NOT INCLUDED</p> <table border="1"> <tr> <td>Code: BRVPNEUPOS65</td> </tr> </table>	DOUBLE ACTING	SINGLE ACTING	Code: BRVPNEUPOS65	<p>PNEUMATIC POSITIONER Air supply pressure 20-90psig, signal range 3-15psig, split range 3-9psig & 9-15psig, 1/4" air connections, housing aluminium, cover impact resistant polyester, cam system S/S, diaphragm Buna N. Operates on force balance principle.</p> <p>APPLICATION: Modulating control of actuator & valve position.</p>	<p><i>Bray Series 65 Pneumatic Positioner</i></p> 
DOUBLE ACTING					
SINGLE ACTING					
Code: BRVPNEUPOS65					

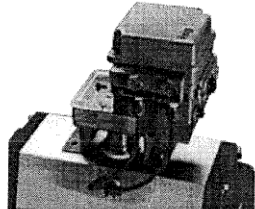
<table border="1"> <tr> <td>DOUBLE ACTING</td> </tr> <tr> <td>SINGLE ACTING</td> </tr> </table> <p>NB. MOUNTING KIT NOT INCLUDED</p> <table border="1"> <tr> <td>Code: BRVELPNPOS65</td> </tr> </table>	DOUBLE ACTING	SINGLE ACTING	Code: BRVELPNPOS65	<p>ELECTRO-PNEUMATIC POSITIONER Air supply pressure 20-90psig, signal range 4-20 milliamp and split ranges, 1/4" air connections, housing aluminium, cover impact resistant polyester, cam system S/S. Operates on force balance principle.</p> <p>APPLICATION: Modulating control of actuator & valve position.</p>	<p><i>Bray Series 65 Electro-Pneumatic Positioner</i></p> 
DOUBLE ACTING					
SINGLE ACTING					
Code: BRVELPNPOS65					

NEW PLYMOUTH STEEL SUPPLIES LTD

BRAY BUTTERFLY VALVES

50mm	65mm	80mm	100mm
125mm	150mm	200mm	250mm
300mm			

Code: _____

CHEMICAL VALVES

BODY - Ductile iron
 - Stainless steel
 - Carbon steel

DISC - Stainless steel
 - PTFE
 - Hastelloy
 - Titanium

SEAT - PTFE
 - Conductive PTFE
 - UHMWPE

Bray Series 22/23 High Performance Chemical Valves

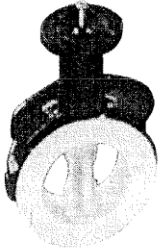

SEAT	EPDM/BUNA	EPDM/BUNA	PTFE	PTFE
DISC	316SS	EPDM/BUNA	316SS	PTFE
25mm				
40mm				
50mm				
65mm				
80mm				
100mm				
125mm				
150mm				
200mm				
250mm				
300mm				

Code: BRVW200

STAINLESS STEEL BODY VALVES

ENDS - Wafer

BODY - 316 s/s

DISC - 316 s/s
 - EPDM encapsulated
 - PTFE encapsulated

SEAT - EPDM
 - BUNA-N
 - PTFE

RATING: Up to 10 bar, 121°C depending on seat/disc material.

APPLICATIONS: Air, water, chemicals, slurries, food products, hydrocarbons, gas, oil, etc.

Bray Series 20 Stainless Steel Bodied Valves

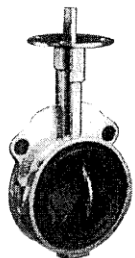

Sizes 50mm (2") thru 1500mm (60")

Code: _____

DAMPER VALVES

BODY - Carbon steel

DISC - Carbon steel

STEM - Stainless steel

Metal seated for non-corrosive gases.

Bray Series 37/38 Damper Valves

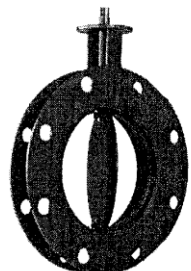

Sizes 600mm (24") thru 1200mm (48")

Code: _____

WATERWORKS/LARGE DIAMETER VALVES

Body options: wafer & flanged.

Material options according to customer requirements.

Bray Series 32/33 & 35/36

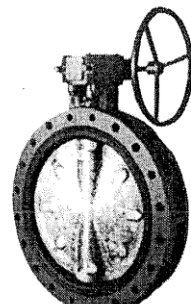

NEW PLYMOUTH STEEL SUPPLIES LTD

BRAY BUTTERFLY VALVES

Manufactured to order.
Price on application.

Code:

EXTENSION ASSEMBLIES

Suitable for Bray lever, gear, pneumatic and electric operators.

MATERIALS - Carbon steel
- Stainless steel

Manufactured to order.

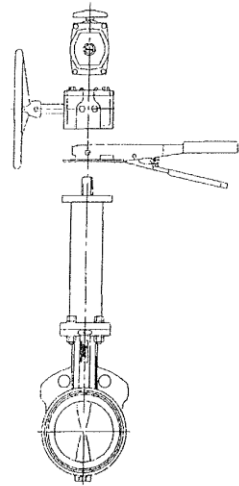

Manufactured to order.
Price on application.

Code:

STEM EXTENSION

For Bray gear operator.

Manufactured to order.

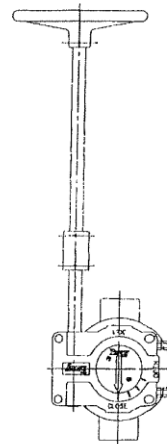

Manufactured to order.
Price on application.

Code:

LINKAGE ASSEMBLY

Operation of two valves by one actuator.

Manufactured to order.

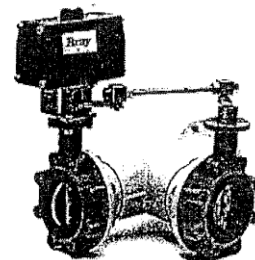

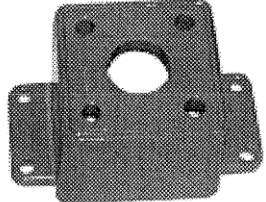

NEW PLYMOUTH STEEL SUPPLIES LTD

BRAY BUTTERFLY VALVES

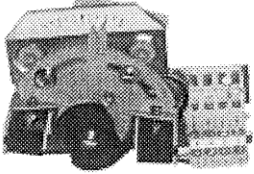
	<p>POSITIONER MTG KIT Adaptor, bracket, hardware, hoses. APPLICATION: Facilitates mounting of Series 65 pneumatic & electro-pneumatic positioner to Series 90/91 actuator.</p>	<p><i>Bray Series 65 Positioner Mounting Kit</i></p> 
Code: BRVPOKIT		

	<p>POSITIONER SWITCHES Mechanical snap-acting micro-switches, SPST for integral mounting into Bray pneumatic and electropneumatic positioners. APPLICATION: For remote end-of-travel position indication.</p>	<p><i>Bray Positioner Switch</i></p> 
Code: BRVSW65/11629 Pneumatic Code: BRVSW65/11630 ElectroPneu		

	<p>STEM ADAPTORS To adapt various valve stem dimensions to gear operator and pneumatic actuator drives.</p>	<p><i>Stem Adaptors for Gear Operators & Pneumatic Actuators</i></p> 
Code: BRVADAPT		

<table border="1"> <thead> <tr> <th>SEAT</th> <th>EPDM</th> <th>BUNA</th> <th>PTFE</th> </tr> </thead> <tbody> <tr><td>25mm</td><td></td><td></td><td>POA</td></tr> <tr><td>40mm</td><td></td><td></td><td>POA</td></tr> <tr><td>50mm</td><td></td><td></td><td>POA</td></tr> <tr><td>65mm</td><td></td><td></td><td>POA</td></tr> <tr><td>80mm</td><td></td><td></td><td>POA</td></tr> <tr><td>100mm</td><td></td><td></td><td>POA</td></tr> <tr><td>125mm</td><td></td><td></td><td>POA</td></tr> <tr><td>150mm</td><td></td><td></td><td>POA</td></tr> <tr><td>200mm</td><td></td><td></td><td>POA</td></tr> <tr><td>250mm</td><td></td><td></td><td>POA</td></tr> <tr><td>300mm</td><td></td><td></td><td>POA</td></tr> </tbody> </table>	SEAT	EPDM	BUNA	PTFE	25mm			POA	40mm			POA	50mm			POA	65mm			POA	80mm			POA	100mm			POA	125mm			POA	150mm			POA	200mm			POA	250mm			POA	300mm			POA	<p>SEAT/LINER OPTIONS EPDM Buna-N (Nitrile) PTFE Silicone Chlorobutyl Viton UHMWPE Refer Bray Material Selection Guide for correct seat type.</p>	
SEAT	EPDM	BUNA	PTFE																																															
25mm			POA																																															
40mm			POA																																															
50mm			POA																																															
65mm			POA																																															
80mm			POA																																															
100mm			POA																																															
125mm			POA																																															
150mm			POA																																															
200mm			POA																																															
250mm			POA																																															
300mm			POA																																															
Code: BRVSE EPDM Code: BRVSB BUNA-N Code: BRVSP PTFE																																																		

	<p>STEM ADAPTORS To adapt various valve stem dimensions to electric actuators.</p>	<p><i>Stem Adaptors for Bray Electric Actuators</i></p> 
Code: BRVADAPTEL		

NEW PLYMOUTH STEEL SUPPLIES LTD

CHECK VALVES

15mm	20mm	25mm	32mm
40mm	50mm		

Code: BVCM

ENDS:
Screwed BSP.

BODY & TRIM:
Brass body and trim, NBR seal, stainless steel spring.

RATING:
Upto 20 bar CWP. -20°C to +100°C.

APPLICATIONS:
Pneumatic & water systems, air conditioning and heating systems. With strainer – a foot valve for irrigation, industrial water supply, water circulation.



Mondial Check Valve

8mm	10mm	15mm	20mm
10 PCS BOX	10 PCS BOX	6 PCS BOX	6 PCS BOX
25mm	32mm	40mm	50mm
6 PCS BOX	4 PCS BOX	4 PCS BOX	2 PCS BOX
65mm	80mm		
1 PCS BOX	1 PCS BOX		

Code: BVVC

ENDS:
Screwed BSP.

BODY & TRIM:
Brass body, polysulfone jumper, nylon 30% glass filler jumper guide, NBR seal, stainless steel spring.

RATING:
From 40 bar CWP for 10mm to 10 bar for 100mm. -30°C to +110°C.

APPLICATIONS:
Pneumatic & water systems, air conditioning and heating systems. With strainer – a foot valve for irrigation, industrial water supply, water circulation.



Bonomi Valstop Spring Check Valve

15mm	20mm	25mm	32mm
40mm	50mm	65mm	80mm
100mm			

Code: BVVS

ENDS:
Screwed BSP.

BODY & TRIM:
Stainless steel basket.

RATING:

APPLICATIONS:
Used with Valstop, Mondial & Europa Check Valves.



Bonomi Valstop Strainer

10mm	15mm	20mm	25mm
32mm	40mm	50mm	

Code: BS107

ENDS:
Screwed BSP.

BODY & TRIM:
Polymer Plastic.

RATING:

APPLICATIONS:
Used with Valstop, Mondial & Europa Check Valves.

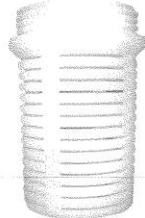

ITAP Polymer Strainer

10mm	15mm	20mm	25mm
10 PCS BOX	10 PCS BOX	8 PCS BOX	6 PCS BOX
32mm	40mm	50mm	65mm
4 PCS BOX	4 PCS BOX	2 PCS BOX	1 PCS BOX
80mm	100mm		
1 PCS BOX	1 PCS BOX		

Code: BVEC

ENDS:
Screwed BSP.

BODY & TRIM:
Brass body, stainless steel plate, NBR seal, stainless steel spring.

RATING:
Upto 18 bar CWP. -30°C to +110°C.

APPLICATIONS:
Pneumatic & water systems, air conditioning and heating systems. With strainer – a foot valve for irrigation, industrial water supply, water circulation.



Europa Check Valve

NEW PLYMOUTH STEEL SUPPLIES LTD

CHECK VALVES

15mm	20mm	25mm	32mm
20 PCS BOX	15 PCS BOX	10 PCS BOX	6 PCS BOX
40mm	50mm		
4 PCS BOX	2 PCS BOX		

Code: BVCS

ENDS:
Screwed BSP.

BODY & TRIM:
Forged brass body and flap with NBR rubber seat.

RATING:
From 12 bar CWP for 15mm to 10 bar for 50mm.

APPLICATIONS:
Water, liquids and gases.

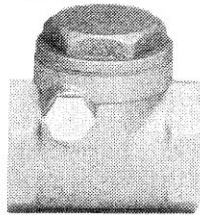

Bonomi Clapet Swing Check Valve with Soft Seat

15mm	20mm	25mm	32mm
20 PCS BOX	15 PCS BOX	10 PCS BOX	6 PCS BOX
40mm	50mm		
4 PCS BOX	2 PCS BOX		

Code: BVCSM

ENDS:
Screwed BSP.

BODY & TRIM:
Forged brass body and flap with metal seat.

RATING:
From 12 bar CWP for 15mm to 10 bar for 50mm.

APPLICATIONS:
Water, liquids and gases.

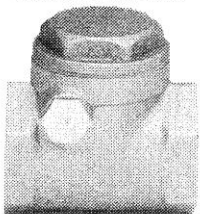

Bonomi Clapet Swing Check Valve with Metal Seat

15mm	20mm	25mm	32mm
40mm	50mm	65mm	80mm
100mm	EXISTING STOCK ONLY		

Code: LVC49

ENDS:
Screwed BSP.

BODY & TRIM:
LG2 cast gunmetal.

RATING:
13.8 bar CWP. Temperature 180°C.

APPLICATIONS:
Hot and cold water, oil, etc.

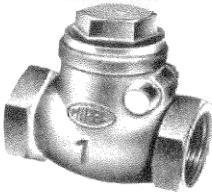

Liquetec LVC49 Swing Check Valve

80mm	100mm	150mm	200mm

Code: SCV

ENDS:
Grooved.

BODY & TRIM:
Ductile iron body, bronze plates.

RATING:
14 bar CWP.

UL listed & FM approved.



Shurjoint 453 UG Dual Plate Check Valve

65mm	80mm	100mm	150mm
200mm			

Code: FCV

ENDS:
Grooved.

BODY & TRIM:
Ductile iron body, seat ring S/S. EPDM faced clapper.

RATING:
21 bar CWP.

UL listed & FM approved.

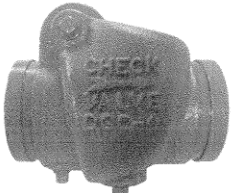

Fivalco

NEW PLYMOUTH STEEL SUPPLIES LTD

CHECK VALVES

50mm	65mm	80mm	100mm
150mm	200mm		

Code: ACVSS

ENDS:
Wafer to suit ANSI 150 flanges.

BODY & TRIM:
316 S/S body, plates and spring, Viton seat.

RATING:
Pressure to ANSI 150. Temp. 150°C.

APPLICATIONS:
Chemical services, liquids and gases, steam.

Astam Stainless Steel Check Valve

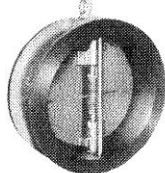

50mm	65mm	80mm	100mm
125mm	150mm	200mm	250mm
300mm			

Code: ACVCI EPDM Seat
Code: ACVB BUNA (NBR) Seat

ENDS:
Wafer for T/E, ANSI 150, PN16.

BODY & TRIM:
CI body, stainless steel discs, EPDM or BUNA seat.

RATING:
16 bar CWP.

Complete with rubber flange gaskets.

Maxflo Check Valve Dual Discs

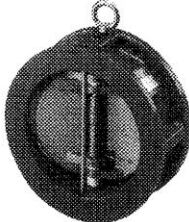

15mm	20mm	25mm	32mm
40mm	50mm		

Code: LVC45

EXISTING STOCK ONLY

ENDS:
Screwed BSP.

BODY & TRIM:
LG2 bronze body, S/S disc and seat.

RATING:
27.5 bar CWP. Temperature 260°C.

APPLICATIONS:
Steam, gases.

Liquetec LVC45 Lift Check Valve

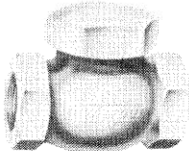

15mm	20mm	25mm	32mm
40mm	50mm		

Code: DKVCHSW

ENDS:
Screwed NPT or socket weld.

BODY & TRIM:
Carbon steel body, 13% chrome S/S trim, full port.

RATING:
Class 800. 136 bar.

APPLICATIONS:
Petrochemical and power plants, general steam use.

DK Piston Check Valve

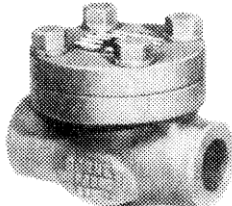

15mm	20mm	25mm	32mm
40mm	50mm		

Code: HSC

ENDS:
Screwed BSP.

BODY & TRIM:
316 S/S.

RATING:
200 psi CWP, up to 230°C.

APPLICATIONS:
Chemicals, food, corrosive environments.

HSY 790 S/S Swing Check Valve

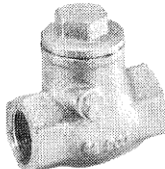

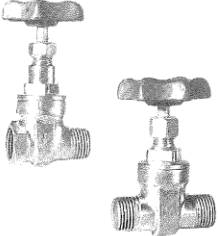

NEW PLYMOUTH STEEL SUPPLIES LTD

GATE VALVES

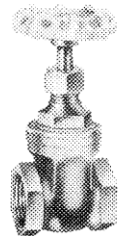
15mm	20mm	EXISTING STOCK ONLY	<p>ENDS: Screwed BSP.</p> <p>BODY & TRIM: Brass, integral seats.</p> <p>RATING: 200 psi CWP.</p> <p>APPLICATIONS: General plumbing, water distribution and light industrial duty.</p>	<p><i>A-Gate Brass Gate Valve</i></p> 
MALE ENDS				
15mm	20mm			
MALE/FEMALE ENDS				
Code: AGVMF				
Code: AGVMM				

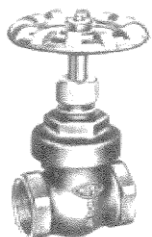
15mm	20mm	25mm	32mm	<p>ENDS: Screwed BSP.</p> <p>BODY & TRIM: Brass, integral seats.</p> <p>RATING: 200 psi CWP.</p> <p>APPLICATIONS: General plumbing, water distribution and light industrial duty.</p>	<p><i>A-Gate Brass Gate Valve</i></p> 
10 PCS BOX		5 PCS BOX			
40mm	50mm	65mm	80mm		
4 PCS BOX		1 PCS BOX			
100mm					
1 PCS BOX					
Code: AGVFF					

10mm	15mm	20mm	25mm	<p>ENDS: Screwed BSP.</p> <p>BODY & TRIM: Bronze body, integral seats, all dezincification resistant.</p> <p>RATING: 14 bar CWP. Temperatures to 180°C.</p> <p>APPLICATIONS: A heavy pattern, corrosion resistant valve for industrial use. Hot and cold liquids, gases, and steam.</p>	<p><i>Liquetec LVG3 Gate Valve</i></p> 
32mm					
40mm		50mm			
Code: LVG3					

15mm	20mm	25mm	32mm	<p>ENDS: Flanged (Undrilled). Can be drilled to T/E & D, ANSI 125 & 150, PN 6 & 10.</p> <p>BODY & TRIM: LG2 bronze body, CZ121 non-dezinc stem. Marine specification to Lloyds Register.</p> <p>RATING: Cold Water or Oil up to 14 bar. Temp. to 175°C.</p> <p>APPLICATIONS: A heavy pattern, corrosion resistant valve for industrial use, marine service/saltwater.</p>	<p><i>Liquetec LVG30 Gate Valve</i></p> 
40mm					
50mm		65mm			
80mm					
Code: LVG30					

NEW PLYMOUTH STEEL SUPPLIES LTD

GATE VALVES

15mm	20mm	25mm	32mm
40mm	50mm		

Code: VVGASW Socket Weld Ends
Code: VVGANPT Screwed Ends

ENDS:
Screwed NPT or socket weld.

BODY & TRIM:
Carbon steel body, 13% chrome S/S trim. Bolted bonnet.

RATING:
Class 800. 136 bar. API 602.

APPLICATIONS:
Petrochemical and power plants, general steam use.

VOGT Gate Valve SW12111



15mm	20mm	25mm	32mm
40mm	50mm		

Code: BFVGA

EXISTING STOCK ONLY

ENDS:
Screwed NPT or socket weld.

BODY & TRIM:
Carbon steel body, 13% chrome S/S trim. Bolted bonnet.

RATING:
Class 800 138 bar (2000 psi) CWP. 55 bar (800 psi) at 450°C.

APPLICATIONS:
Petrochemical and power plants, general steam use.

Bonney Forge Gate Valve

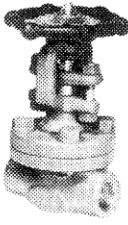

15mm	20mm	25mm	32mm
40mm	50mm		

Code: DKVGASW

ENDS:
Socket weld.

BODY & TRIM:
Carbon steel body. 13% chrome S/S trim. Bolted bonnet.

RATING:
Class 800 136 bar.

APPLICATIONS:
Petrochemical and power plants, general steam use.

DK Gate Valve

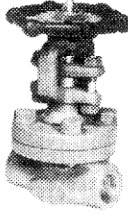

65mm	80mm	100mm	150mm
200mm	250mm	300mm	

Code: NEWGA150CS
Code: KJVGA150CS
Code: SUVGA150CS

ENDS:
ANSI 150, ANSI B16.5.

BODY & TRIM:
ASTM A216 WCB. Trim API No. 8, 13% CR/Half Stellite.

RATING:
ANSI B16.34, Class 150.

APPLICATIONS:
Steam, water, hydrocarbons and petrochem industries.

Steel Gate Valve

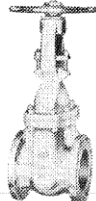

80mm	100mm	150mm	200mm

Code: SUVGA150SS

ENDS:
ANSI 150, ANSI B16.5.

BODY & TRIM:
ASTM A351, CF8M. Trim API No. 10.

RATING:
ANSI B16.34, Class 150.

APPLICATIONS:
Steam, water, hydrocarbons and chemicals.

SUFA Stainless Steel Gate Valve

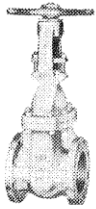

NEW PLYMOUTH STEEL SUPPLIES LTD

GATE VALVES

50mm	65mm	80mm	100mm
125mm	150mm	200mm	
250mm	300mm		

Code: MVCIGE

ENDS:
BS10 T/E drilled.

BODY & TRIM:
CI body, inside screw non-rising stem, with position indicator.

RATING:
13.8 bar.

APPLICATIONS:
General industrial and mechanical services.

*Maxiflo Cast Iron Gate Valve
Non-Rising Stem*



200mm	250mm	300mm

Code: MVCIGRS

ENDS:
BS10 T/E drilled.

BODY & TRIM:
CI body, bronze trim, outside screw and yoke.

RATING:
13.8 bar.

APPLICATIONS:
General industrial and mechanical services.

*Maxiflo Cast Iron Gate Valve
Rising Stem OS & Y*



100mm	150mm

Code: SVGV

ENDS:
Grooved.

BODY & TRIM:
ductile iron body with EPDM encapsulated gate.

RATING:
14 bar CWP.

APPLICATIONS:
Epoxy coated body.
UL/FM listed
for fire protection service.

*SHURJOINT 722G OS+Y
Gate Valve*



50mm	65mm	80mm	100mm
150mm	200mm	250mm	300mm

Code: SVFH

ENDS:
Flanged to AS4087 Fig. B-5 (bolting same as AS2129 T/D).

BODY & TRIM:
Body and bonnet ductile iron fusion bonded epoxy coated. Wedge rubber coated. Clockwise closing with handwheel. Manufactured to AS2638.2-2002. Certified to AS4020 for use on drinking water. Standards Mark Licence SMKP 20171.

RATING:
Valve rated to 16 bar.

*SUFA Resilient Seat
Gate Valve*



NEW PLYMOUTH STEEL SUPPLIES LTD

GATE VALVES

15mm	20mm	25mm	32mm	<p>ENDS: Screwed BSP.</p> <p>BODY & TRIM: ASTM CF8M 316 S/S body, bonnet spindle wedge and seats.</p> <p>RATING: 200 psi – 14 bar CWP.</p> <p>APPLICATIONS: Corrosive fluids/gases. Food, drug, chemical process.</p>	<p><i>HSY Fig. GT-200 S/S Gate Valve</i></p> 
	40mm	50mm			
Code: HSGAVSS					

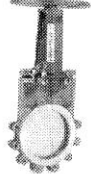
50mm	80mm	100mm	150mm	<p>ENDS: To suit ANSI 150.</p> <p>BODY & TRIM: 316 S/S body and gate, S/S upstand and bolts/nuts, EPDM resilient perimeter seal.</p> <p>RATING: 10 bar CWP.</p> <p>APPLICATIONS: Pulp stock, slurries, sewage, etc.</p>	<p><i>FABRI C67S Knife Gate Valve S/S Body & Perimeter Seal</i></p> 
	200mm	250mm	300mm		
Code: FAVC67S					

80mm	100mm	125mm	150mm	<p>ENDS: To suit ANSI 150, tapped metric To suit BS10 T/E, tapped metric</p> <p>BODY & TRIM: 316 S/S body and gate EPDM seat</p> <p>APPLICATIONS: Pulp stock, slurries, sewage, etc.</p>	<p><i>CMO Type A Knife Gate Valve</i></p> 
	200mm	250mm	300mm		
Code: CMVA5V2I1		ANSI 150			
Code: CMVA7V2I1		BS10 T/E			

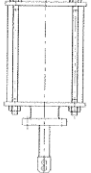
80mm	100mm	150mm	200mm	<p>Pneumatic Actuator, double acting to suit CMO Type A Knife Gate Valve</p>	<p><i>CMO Actuator</i></p> 
	250mm	300mm			
Code: CMA					

15mm	25mm	32mm	40mm	<p>ENDS: Screwed BSP.</p> <p>BODY & TRIM: Brass, integral seats, pressed metal handwheel.</p> <p>RATING: 10 bar CWP.</p> <p>APPLICATIONS: Irrigation.</p>	<p><i>ITAP 155 Brass Gate Valve</i></p> 
20 PCS BOX	20 PCS BOX	10 PCS BOX	10 PCS BOX		
	65mm	100mm			
	1 PCS BOX	1 PCS BOX			
Code: ITVG					

NEW PLYMOUTH STEEL SUPPLIES LTD

GLOBE VALVES

8mm	10mm	15mm	20mm
25mm	40mm	50mm	

Code: LVS16

ENDS:
Screwed BSP.

BODY & TRIM:
Bronze with integral seat and renewable composition disc.

RATING:
27 bar CWP. 13.6 bar steam.
Temperatures to 230°C.

APPLICATIONS:
Medium and low pressure steam services, also water supply, compressed air, oil and petrol.

Liquetec LVS16 Globe Valve



8mm	10mm	15mm	20mm
25mm	32mm	40mm	50mm

Code: LVS11

ENDS:
Screwed BSP.

BODY & TRIM:
Bronze, with union bonnet, and with stainless steel seat and disc.

RATING:
41 bar CWP. 20 bar steam. Temperatures to 260°C.

APPLICATIONS:
Medium pressure boiler and steam services, also cold services.

Liquetec LVS11 Globe Valve



15mm	20mm	25mm	32mm
40mm	50mm		

Code: LVS12

ENDS:
Flanged DIN PN16 (undrilled).

BODY & TRIM:
Bronze, with union bonnet, and with bronze seat and disc.

RATING:
15.5 bar CWP. 10 bar steam.
Temperatures to 260°C.

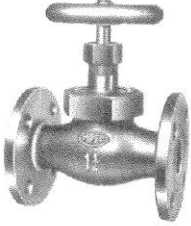

APPLICATIONS:
Medium pressure boiler and steam services, also cold services.

Liquetec LVS12 Globe Valve





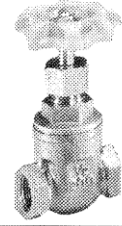
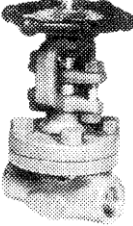

NEW PLYMOUTH STEEL SUPPLIES LTD

GLOBE VALVES

<table border="1"> <thead> <tr> <th>15mm</th> <th>20mm</th> <th>25mm</th> <th>32mm</th> </tr> </thead> <tbody> <tr> <td></td> <td></td> <td></td> <td></td> </tr> <tr> <th>40mm</th> <th>50mm</th> <td></td> <td></td> </tr> <tr> <td></td> <td></td> <td></td> <td></td> </tr> </tbody> </table> <p>Code: HSGLVSS</p>	15mm	20mm	25mm	32mm					40mm	50mm							<p>ENDS: Screwed BSP.</p> <p>BODY & TRIM: ASTM CF8M 316 S/S body, bonnet, spindle and seats.</p> <p>RATING: 200 psi – 14 bar CWP.</p> <p>APPLICATIONS: Corrosive fluids/gases. Food, drug, chemical process.</p>	<p><i>HSY Fig. GB-200 S/S Globe Valve</i></p> 
15mm	20mm	25mm	32mm															
40mm	50mm																	
<table border="1"> <thead> <tr> <th>15mm</th> <th>20mm</th> <th>25mm</th> <th>32mm</th> </tr> </thead> <tbody> <tr> <td></td> <td></td> <td></td> <td></td> </tr> <tr> <th>40mm</th> <th>50mm</th> <td></td> <td></td> </tr> <tr> <td></td> <td></td> <td></td> <td></td> </tr> </tbody> </table> <p>EXISTING STOCK ONLY</p> <p>Code: BFVGL</p>	15mm	20mm	25mm	32mm					40mm	50mm							<p>ENDS: Screwed NPT or socket weld.</p> <p>BODY & TRIM: Carbon steel body, 13% chrome S/S trim. Bolted bonnet.</p> <p>RATING: Class 800 138 bar (2000 psi) CWP. 55 bar (800 psi) at 450°C.</p> <p>APPLICATIONS: Petrochemical and power plants, general steam use.</p>	<p><i>Bonney Forge Globe Valve</i></p> 
15mm	20mm	25mm	32mm															
40mm	50mm																	
<table border="1"> <thead> <tr> <th>15mm</th> <th>20mm</th> <th>25mm</th> <th>32mm</th> </tr> </thead> <tbody> <tr> <td></td> <td></td> <td></td> <td></td> </tr> <tr> <th>40mm</th> <th>50mm</th> <td></td> <td></td> </tr> <tr> <td></td> <td></td> <td></td> <td></td> </tr> </tbody> </table> <p>Code: DKVGLSW</p>	15mm	20mm	25mm	32mm					40mm	50mm							<p>ENDS: Socket weld.</p> <p>BODY & TRIM: Carbon steel body, 13% chrome S/S trim. Bolted bonnet.</p> <p>RATING: Class 800 136 bar.</p> <p>APPLICATIONS: Petrochemical and power plants, general steam use.</p>	<p><i>DK Globe Valve</i></p> 
15mm	20mm	25mm	32mm															
40mm	50mm																	
<table border="1"> <thead> <tr> <th>8mm</th> <th>10mm</th> <th>15mm</th> </tr> </thead> <tbody> <tr> <td></td> <td></td> <td></td> </tr> </tbody> </table> <p>Code: VMNV</p>	8mm	10mm	15mm				<p>ENDS: Screwed BSPT.</p> <p>BODY & TRIM: 316SS, PTFE Packing.</p> <p>RATING: 6000 PSI, 413 Bar.</p>	<p><i>VM Needle Valve ND6000</i></p> 										
8mm	10mm	15mm																

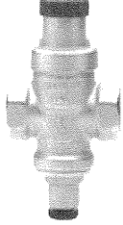
NEW PLYMOUTH STEEL SUPPLIES LTD

MISCELLANEOUS VALVES

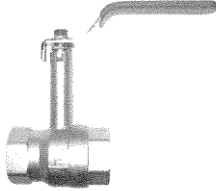
<table border="1"> <thead> <tr> <th>15mm</th> <th>20mm</th> </tr> </thead> <tbody> <tr> <td> </td> <td> </td> </tr> </tbody> </table> <p>Code: BVPR361</p>	15mm	20mm			<p>ENDS: Screwed BSP.</p> <p>BODY & TRIM: Brass body, S/S seat, NBR seal.</p> <p>RATING: Inlet pressure up to 15 bar. Outlet pressure 0.5 to 4 bar. Temperature to 80°C.</p>	<p><i>Itap 361 Pressure Reducing Valve</i></p> 				
15mm	20mm									
<table border="1"> <thead> <tr> <th>32mm</th> <th>40mm</th> <th>50mm</th> <th>65mm</th> </tr> </thead> <tbody> <tr> <td> </td> <td> </td> <td> </td> <td> </td> </tr> </tbody> </table> <p>ALSO AVAILABLE TO ORDER WITH IP65 RATED SWITCH BOX – CODE VVMIP65</p> <p>Code: VVM</p>	32mm	40mm	50mm	65mm					<p>ENDS: Screwed BSP.</p> <p>BODY & TRIM: Brass nickel plated full bore ball valve rated to 25 bar. Monitored valve for fire sprinkler systems. Complete with tamper proof switch box. Insurance Council listed Certificate No. 461.</p>	<p><i>Vitech 12-9 Fire Sprinkler Ball Valve</i></p> 
32mm	40mm	50mm	65mm							
<table border="1"> <thead> <tr> <th>65mm</th> </tr> </thead> <tbody> <tr> <td> </td> </tr> </tbody> </table> <p>Code: MVFH</p>	65mm		<p>ENDS: Screwed BSP.</p> <p>BODY & TRIM: Brass nickel plated full bore valve.</p> <p>Fire hydrant riser and outlet valve. Lockable ratchet lever handle.</p> <p>Insurance Council listed. Certificate No. 462.</p>	<p><i>Maxiflo Landing Valve</i></p> 						
65mm										
<table border="1"> <thead> <tr> <th>65mm</th> </tr> </thead> <tbody> <tr> <td> </td> </tr> </tbody> </table> <p>Code: MVBCS</p>	65mm		<p>ENDS: Screwed BSP.</p> <p>BODY & TRIM: Brass.</p> <p>RATING: 200 psi, 14 bar.</p>	<p><i>Maxiflo Swing Check Valve</i></p> 						
65mm										
<table border="1"> <thead> <tr> <th>15mm</th> <th>20mm</th> <th>25mm</th> </tr> </thead> <tbody> <tr> <td> </td> <td> </td> <td> </td> </tr> </tbody> </table> <p>Code: ABVX</p>	15mm	20mm	25mm				<p>ENDS: BSP Taper F/F.</p> <p>BODY & TRIM: Nickel plated brass body, full bore chrome plated brass ball PTFE seats.</p> <p>RATING: CWP – 20 bar. Max temp 150°C.</p> <p>APPLICATIONS: For insulated pipelines.</p>	<p><i>Asmuss Xstemball Valve</i></p> 		
15mm	20mm	25mm								

NEW PLYMOUTH STEEL SUPPLIES LTD

STRAINERS

15mm	20mm	25mm	32mm
40mm	50mm		

Code: BYS192

ENDS:
Screwed BSP.

BODY & TRIM:
Brass body, S/S screen.

RATING:
16 bar CWP.

ITAP 192 Brass Strainer

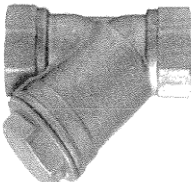

15mm	20mm	25mm	32mm
40mm	50mm		

Code: TVVS

ENDS:
Screwed BSPT.

BODY & TRIM:
Bronze with S/S screen, 40 mesh.

RATING:
10 bar (150 psig).

APPLICATIONS:
Water, steam, gases, etc.

Toyo 380 Strainer

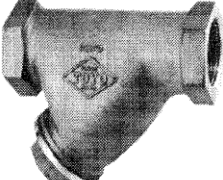

15mm	20mm	25mm	32mm
40mm	50mm		

Code: ABVS316

ENDS:
Screwed BSP.

BODY & TRIM:
316 S/S with S/S screen.

RATING:
800 psi.

APPLICATIONS:
Chemicals, liquids and gases.

Concord YS-800 Strainer

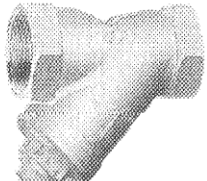

250mm
1,745.00

**AVAILABLE
WHILE
STOCKS LAST**

Code: AVASTRY

ENDS:
Flanged BS10 T/E.

BODY & TRIM:
Cast iron with S/S basket.

RATING:
16 bar CWP.

Arita AVA Strainer

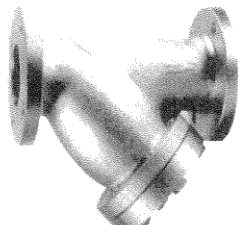

50mm	65mm	80mm	100mm
125mm	150mm	200mm	250mm
300mm			

Code: HWS

ENDS:
Flanged AS2129 T/E.

BODY & TRIM:
Cast iron with S/S basket.

RATING:
16 bar CWP.
Temp 120°C.

Asmuss Y-Strainer

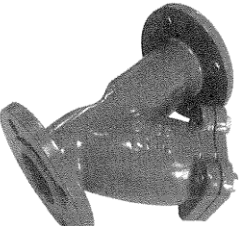

NEW PLYMOUTH STEEL SUPPLIES LTD

TOSACA SAFETY RELIEF VALVES

REFER TO COMPUTER FOR
CURRENT SIZES & STOCK
FROM 15mm & UP

Code: TV800ML	Metal Seat
Code: TV800VL	Viton Seat

Tosaca Model 800,
Ends Screwed BSP,
Bronze Body.
Viton or Metal Seat,
with Lever.

Bronze Body



REFER TO COMPUTER FOR
CURRENT SIZES & STOCK
FROM 15mm & UP

Code: TV800M	Metal Seat
Code: TV800V	Viton Seat

Tosaca Model 800,
Ends Screwed BSP,
Bronze Body.
Viton or Metal Seat,
Closed Bonnet.

Bronze Body



Size Inlet / Outlet

32x32	40x50	50x50

Code: TV1216FML	Metal Seat
Code: TV1216FVL	Viton Seat

Tosaca Model 1216F,
Ends Screwed BSP,
Stainless Body.
Viton or Metal Seat,
with Lever.

Stainless Body



Size Inlet / Outlet

32x32	40x50	50x50

Code: TV1216FM	Metal Seat
Code: TV1216FV	Viton Seat

Tosaca Model 1216F,
Ends Screwed BSP,
Stainless Body.
Viton or Metal Seat,
Closed Bonnet.

Stainless Body



ASMUSS
ACTUATORS

MODELS: PW TO P50
PWS TO P50S

POA

PRISMA PNEUMATIC ACTUATORS:

- Double acting and
- Spring return

BODY MATERIALS:

- Aluminium
- Polyamide
- Stainless steel



POA

PRISMA ACTUATOR ACCESSORIES:

- Limit switches
- Proximity switches
- Positioners
- Position transmitters
- Solenoids
- Manual override
- Mounting kits

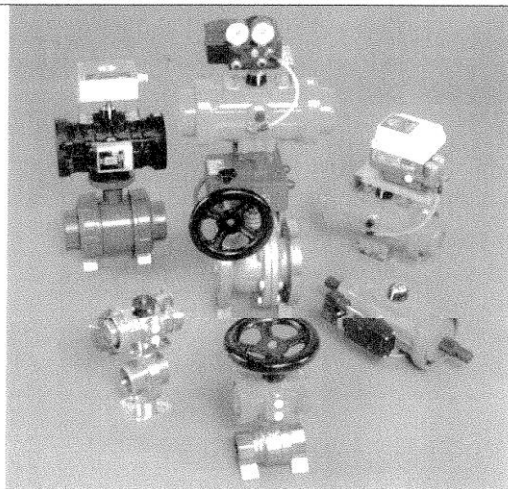

LT

LIMITORQUE ELECTRIC ACTUATORS: MX SERIES

- Torques up to 2307 Nm
- Multiturn + quarter turn
- Manual override
- On/Off or modulating
- Limit + torque switches
- All voltages
- Rising + non-rising spindle
- LCD display

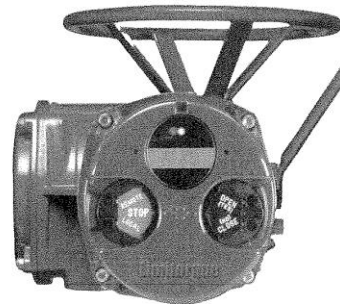

NA

NOAH ELECTRIC ACTUATORS:

- Torques 60 to 2500 Nm
- Quarter turn
- Manual override
- On/Off or modulating
- Limit + torque switches
- All voltages



ACTUATED VALVES

Swiftomatic Ball Valves c/w Pneumatic Actuators

Valve Size	Valve Code	Double Acting Code	Price for Valve & D/Acting Actuator
15	BVSW/015	BADA/015-025	
20	BVSW/020	BADA/015-025	
25	BVSW/025	BADA/015-025	
32	BVSW/032	BADA/032-050	
40	BVSW/040	BADA/032-050	
50	BVSW/050	BADA/032-050	
65	BVSW/065	BADA/065-080	
80	BVSW/080	BADA/065-080	
Valve Size	Valve Code	Spring Close Code	Price for Valve & Spring Close Actuator
15	BVSW/015	BASR/015-025	
20	BVSW/020	BASR/015-025	
25	BVSW/025	BASR/015-025	
32	BVSW/032	BASR/032-040	
40	BVSW/040	BASR/032-040	
50	BVSW/050	BASR/050	

ENDS:
BSP F/F.

BODY & TRIM:
Nickel plated brass body, full bore chrome plated brass ball PTFE seats.

RATING:
CWP – 16 bar size 15mm-32mm;
10 bar size 40mm-80mm at ambient temperature.

Actuator selections based on 5 Bar air supply and valves on liquid service.

Swiftomatic Valves and Actuators

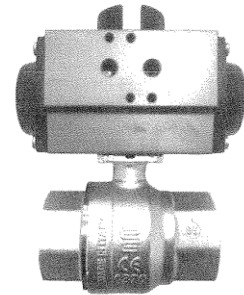

80mm to 1500mm

Code: NJL1

ENDS:
Wafer and lugged.

BODY & TRIM:
C/S, S/S, titanium and alloy 20, metal seats, c/w pneumatic actuators and positioners.

RATING:
ANSI Class 150 to 600, CV's from 270 to 87,000.

APPLICATIONS:
For control of liquids, gases, steam, liquors, stock, etc.

Neles Eccentric Disc Control Valves

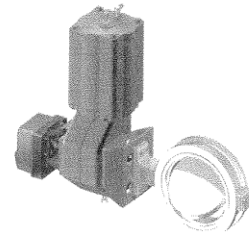

25mm to 400mm

Code: NJR1

ENDS:
Wafer and flanged.

BODY & TRIM:
C/S, S/S, titanium, etc. Metal and PTFE seats, c/s pneumatic actuators and positioners.

RATING:
ANSI Class 150 to 300, CV's from 0.5 to 5,270.

APPLICATIONS:
For precise control of gases, liquids, stream, slurries, stock, etc.

Neles Segment Type Control Valve

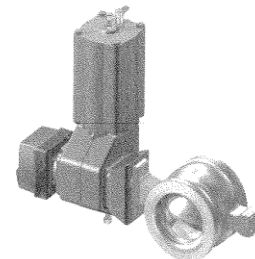

NEW PLYMOUTH STEEL SUPPLIES LTD

Code **Description**

FLCS/015 15mm Flamco Connection Set 27290
For vessels 35-300 litres



FLCS//025 25mm Flamco Connection Set 27293
For vessels 110-1000 litres



FLAV/015 15mm Flamco Air Vent Flexvent 27740



FLF/015 15mm Flamco Funnel 27350
FLF/020 20mm Flamco Funnel 27360
FLF/025 25mm Flamco Funnel 27325
FLF/032 32mm Flamco Funnel 27330



FLAS/020 20mm Flamcovent Air Seperator 28020
FLAS/025 25mm Flamcovent Air Seperator 28021
FLAS/032 32mm Flamcovent Air Seperator 28022
FLAS/040 40mm Flamcovent Air Seperator 28023



FLSV015/27665 3 Bar Flamco Prescor Safety Valve 15mm
FLSV020/27025 3 Bar Flamco Prescor Safety Valve 20mm
FLSV025/27045 3 Bar Flamco Prescor Safety Valve 25mm
FLSV032/27056 3 Bar Flamco Prescor Safety Valve 32mm
FLSV27049 5 Bar Flamco Prescor Safety Valve 25mm
FLSV27039 5 Bar Flamco Prescor Safety Valve 32mm

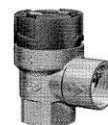

FLWM27913 Flamco Flexcon MB2 Wall Mounting Clip 27913
For vessels 2-25 litres



NEW PLYMOUTH STEEL SUPPLIES LTD

FLWM27910 Flamco Flexconsole 8-25 Wall Mounting 27910
For vessels 8-25 litres

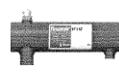

Code Description

FLWM27996 Flamco Flexconsole Plus 8-25 Wall Mounting
For vessels 8-25 litres

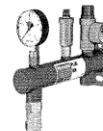

Flamco Expsn Vessels Charge Press 1.5 Bar

FLEV8/16077 Flamco C8 Expsn Vessel 16077 max 3 Bar
 FLEV12/16127 Flamco C12 Expsn Vessel 16127 max 3 bar
 FLEV18/16177 Flamco C18 Expsn Vessel 16177 max 3 Bar
 FLEV25/16247 Flamco C25 Expsn Vessel 16247 max 3 bar



FLEV35/16347 Flamco C35 Expsn Vessel 16347 max 3 bar
 FLEV50/16493 Flamco C50 Expsn Vessel 16493 max 3 bar
 FLEV80/16817 Flamco C80 Expsn Vessel 16817 max 3 bar



Flamco Expsn Vessels Charge Press 2 Bar

FLEV110/16110 Flamco 110 Expsn Vessel 16110 max 6 bar
 FLEV140/16141 Flamco 140 Expsn Vessel 16141 max 6 bar
 FLEV200/16208 Flamco 200 Expsn Vessel 16208 max 6 bar
 FLEV300/16304 Flamco 300 Expsn Vessel 16304 max 6 bar
 FLEV425/16424 Flamco 425 Expsn Vessel 16424 max 6 bar
 FLEV600/16604 Flamco 600 Expsn Vessel 16604 max 6 bar
 FLEV800/16804 Flamco 800 Expsn Vessel 16804 max 6 bar



FLSP27925 Flamco Disassembly Spanner DT 27925

NEW PLYMOUTH STEEL SUPPLIES LTD

Frese Auto Balancing Valves

Frese

15mm
20mm
25mm
25Lmm
32mm
40mm
50mm

Frese Alpha Automatic Balancing Valve
With 2 x 1" P/T Plugs, F/F Threads
Screwed BSP Parallel
Brass DR Body

Automatic Balancing Valve Body

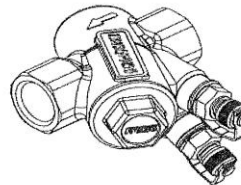

Code: FVA

15mm
20mm
25mm
25Lmm
32mm
40mm

Frese Alpha Automatic Balancing Valve
With 2 x 1" P/T Plugs
Fixed end Female & Female Union
With BSP Parallel Threads
Brass DR Body
Complete with Ball Valve & Handle

Automatic Balancing Valve Body
With Ball Valve

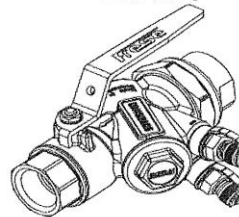

Code: FVAB

50mm W
65mm
80mm
100mm

Frese Alpha Automatic Balancing Valve
With 2 x 2" P/T Plugs
Wafer Type Body
Cast Steel

Automatic Balancing Valve Body
Wafer Type

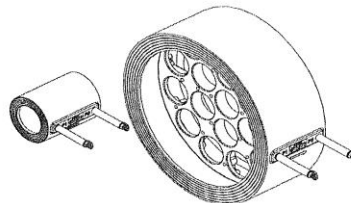

Code: FVA

Type 10
Type 11
Type 12
Type 30
Type 40

Frese High Pressure Alpha Cartridge
Tin / Nickel Plated Brass DR

Alpha Cartridge



Code: FC49

Type 10
Type 11
Type 12
Type 30
Type 40

Frese Oriface Plate
Tin / Nickel Plated Brass DR

Alpha Orifice

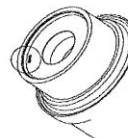

Code: FO49

10

NEW PLYMOUTH STEEL SUPPLIES LTD



VALVES & ACCESSORIES

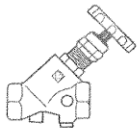

STROMAX 4115 INCLINED VALVE	CODE
15mm Stromax Valve	HVS/1411501
20mm Stromax Valve	HVS/1411502
25mm Stromax Valve	HVS/1411503
32mm Stromax Valve	HVS/1411504
50mm Stromax Valve	HVS/1411506
80mm Stromax Valve	HVS/1411508

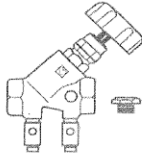

STROMAX-M 4117 CIRCUIT REG V/V WITH MEASURING V/V	CODE
15mm Stromax Valve	HVS/1411751
20mm Stromax Valve	HVS/1411752
25mm Stromax Valve	HVS/1411753

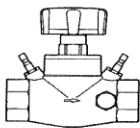

STROMAX 4217 GM CIRCUIT REG V/V WITH MEASURING V/V	CODE
15mm Stromax Valve	HVS/1421711
20mm Stromax Valve	HVS/1421712
25mm Stromax Valve	HVS/1421713
32mm Stromax Valve	HVS/1421714
40mm Stromax Valve	HVS/1421715
50mm Stromax Valve	HVS/1421716
65mm Stromax Valve	HVS/1421717
80mm Stromax Valve	HVS/1421718

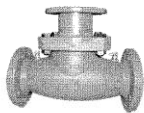

STROMAX GF FLGD CIRCUIT V/V WITH MEASURING V/V	CODE
50mm Stromax GF Valve	HVS/1421870GF
65mm Stromax GF Valve	HVS/1421871GF
80mm Stromax GF Valve	HVS/1421872GF
100mm Stromax GF Valve	HVS/1421873GF

Sizes 125mm to 300mm available on indent

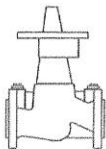

STROMAX-GMF & MFS CIRCUIT V/V WITH MEASURING V/V	CODE
50mm Stromax GMF Valve	HVS/1421846
65mm Stromax GMF Valve	HVS/1421847
80mm Stromax GMF Valve	HVS/1421848
100mm Stromax MFS Valve	HVS/1421809

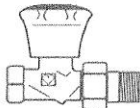

DR-T-90 RADIATOR CONTROL VALVE - STRAIGHT MODEL	CODE
15mm DR-T-90 STR	HVR/1682391
20mm DR-T-90 STR	HVR/1682392
25mm DR-T-90 STR	HVR/1682373

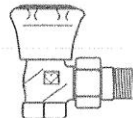

DR-T-90 RADIATOR CONTROL VALVE - ANGLE MODEL	CODE
15mm DR-T-90 STR/LS	HVR/1682491
20mm DR-T-90 STR/LS	HVR/1682492
25mm DR-T-90 STR/LS	HVR/1682473

FOR INFORMATION AND ORDERS CALL 09-573 0099 CALL FREE 0800-ASMUSS FAX 09-573 5590

NEW PLYMOUTH STEEL SUPPLIES LTD



VALVES & ACCESSORIES









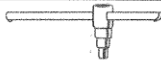

	DR-T-90 RADIATOR CONTROL VALVE - LOCKSHIELD STRAIGHT MODEL 15mm DR-T-90 STR/LS 20mm DR-T-90 STR/LS 25mm DR-T-90 STR/LS	CODE HVR/1682381 HVR/1682382 HVR/1682386
	DR-T-90 RADIATOR CONTROL VALVE - LOCKSHIELD ANGLE MODEL 15mm DR-T-90 Ang/LS 20mm DR-T-90 Ang/LS 25mm DR-T-90 Ang/LS	HVR/1682481 HVR/1682482 HVR/1682486
	TS-90 THERMOSTATIC VALVE - STRAIGHT MODEL 15mm TS-90 STR 20mm TS-90 STR	HVR/1772391 HVR/1772392
	TS-90 THERMOSTATIC VALVE - ANGLE MODEL 15mm TS-90 Ang 20mm TS-90 Ang	HVR/1772491 HVR/1772492
	TS-90 THERMOSTATIC VALVE - REVERSE ANGLE MODEL 15mm TS-90 Rev Ang	HVR/1772891
	THERMOSTATIC HEAD Thermostatic Head Herzules Anti-Vandal Head	HVT/1723006 HVT/1986010
	THERMOSTAT WITH REMOTE ADJUSTMENT Thermostat Remote	HVT/1733005
	THERMOSTAT WITH REMOTE SENSOR Thermostat Remote	HVT/7450
	FILL AND DRAIN COCK 15mm Drain Cock Itap 139 20mm Drain Cock Herz 4119	HVD/1411901 HVD/1400902

FOR INFORMATION AND ORDERS CALL 09-573 0099 CALL FREE 0800-ASMUSS FAX 09-573 5590

NEW PLYMOUTH STEEL SUPPLIES LTD



VALVES & ACCESSORIES

	HOSE CONNECTION 15mm Hose Conn	CODE HVH/1620601
	CONNECTION ELBOW 15mm Conn Elbow	HVE/1624901
	PRESETTING KEY Yellow Shaft Blue Shaft	HVK/1680000 HVK/1660000
	ASSEMBLY KEY Assembly Key	HVK/1668000
	THEFT PROTECTION Theft Protection	HVP/1755203
	O RING SET O-Ring Set	HVO/1671000
	MEASURING VALVE FOR STROMAX-M 1/4" Measuring Valve	HVV/1028009
	THERMOSTATIC UPPER PART Thermostatic Adaptor	HVT/1637600
	HANDWHEEL FOR HERZ-DR-T-0-90 Handwheel	HVH/1651090
	LOCKSHIELD FOR HERZ-DR-T-90 Lockshield	HVL/1651290
	BINDER TEST POINTS 8mm Red 8mm Blue	HVTPR/008 HVTPB/008
	AIR RELEASE VALVE Itap Fig 194	HVAR/008

FOR INFORMATION AND ORDERS CALL 09-573 0099 CALL FREE 0800-ASMUSS FAX 09-573 5590